

# KALDEWEI

**DICHTSET FLEX | SEALING KIT FLEX | KIT D'ÉTANCHÉITÉ FLEX  
SET PER SIGILLATURA FLEX | JUEGO DE ESTANQUEIZACIÓN FLEX**

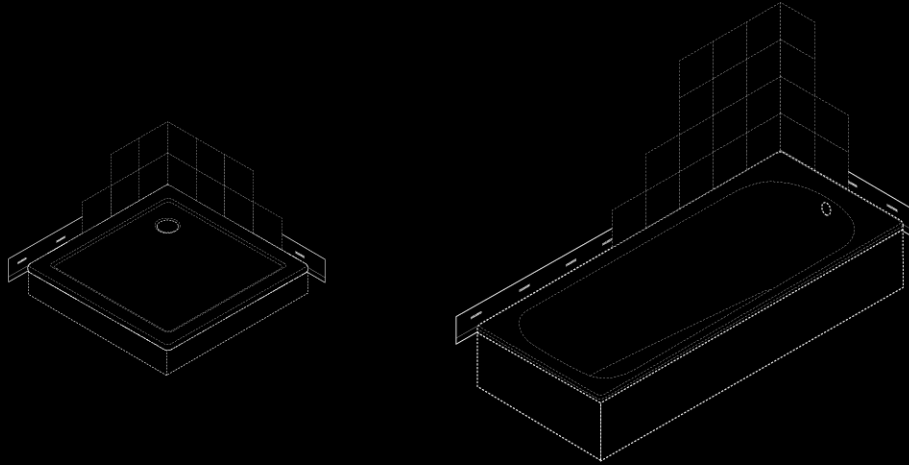

# 2

## **DE Montageanleitung | EN Installation instructions**

NL Montagehandleiding | FR Instructions de montage | IT Istruzioni di montaggio  
ES Instrucciones de montaje | PT Instruções de montagem | DA Monteringsvejledning  
NO Monteringsanvisning | SV Monteringsanvisning | FI Aseennusohje | ET Paigaldusjuhised  
LV Montāžas instrukcija | LT Montavimo instrukcija | PL Instrukcja montażu | CS Návod k montáži  
RU Инструкция по монтажу | UK Інструкція з монтажу | SK Návod na montáž | HU Összeszerelési utasítás | RO Instrucțiuni de montare | SL Navodila za montažo | HR Upute za montažu  
BG Ръководство за монтаж | EL Οδηγίες συναρμολόγησης | TR Montaj talimatı | AR بيكي كرتلا ليلد  
ZH 安装说明书 | JA 設置説明書 | KO 조립설명서 | ID Petunjuk perakitan | TH คำแนะนำในการติดตั้ง  
VI Hướng dẫn lắp ráp | HI स्थापना निर्देश

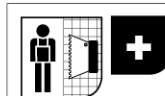
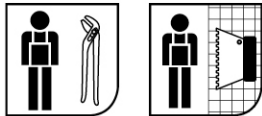
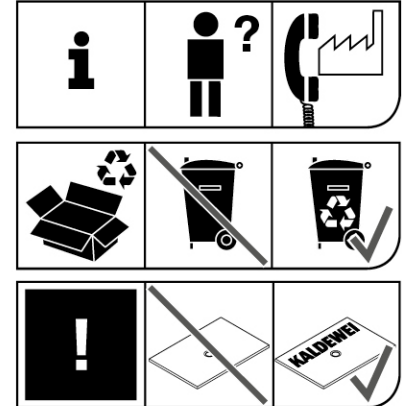
**1.****2.**

DIN EN 18 157  
DIN 52 460  
DIN 18 534



# DICHTSET FLEX

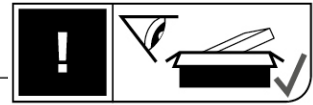

**A**

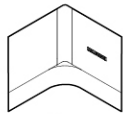
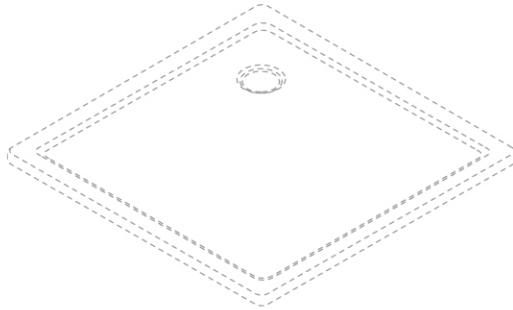

2x



5,0 m



Inch = mm x 0,0394

**B**

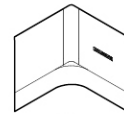
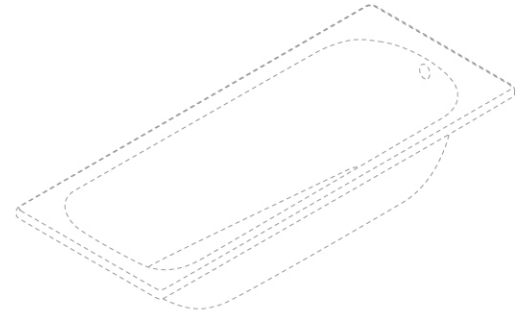
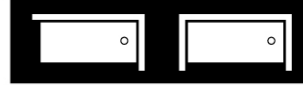

2x



5,0 m

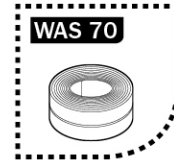

Inch = mm x 0,0394

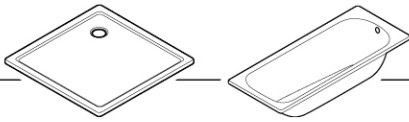
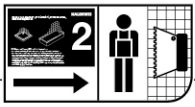

**3.**

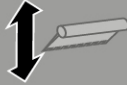
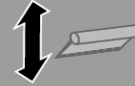
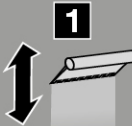
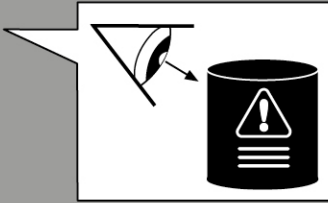

		<b>A</b>	S.5
		<b>B</b>	S.19

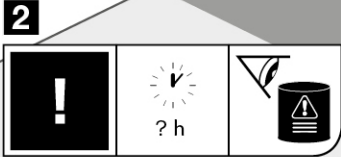

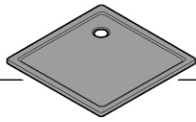

**A 4.**

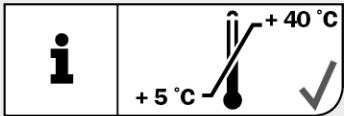
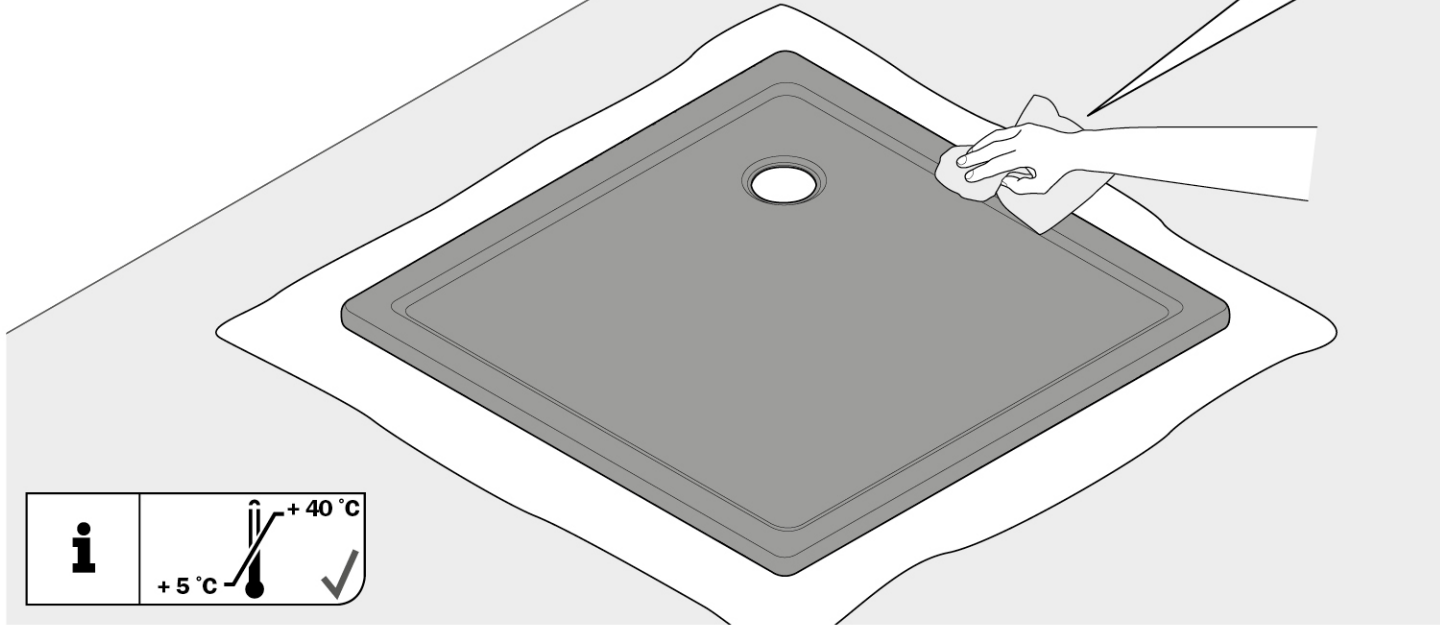
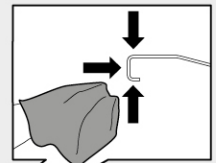
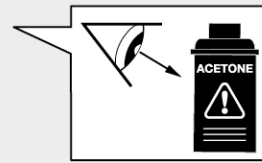
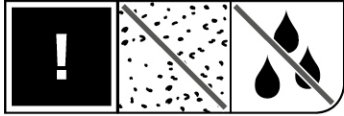

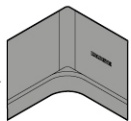

**A 5.**

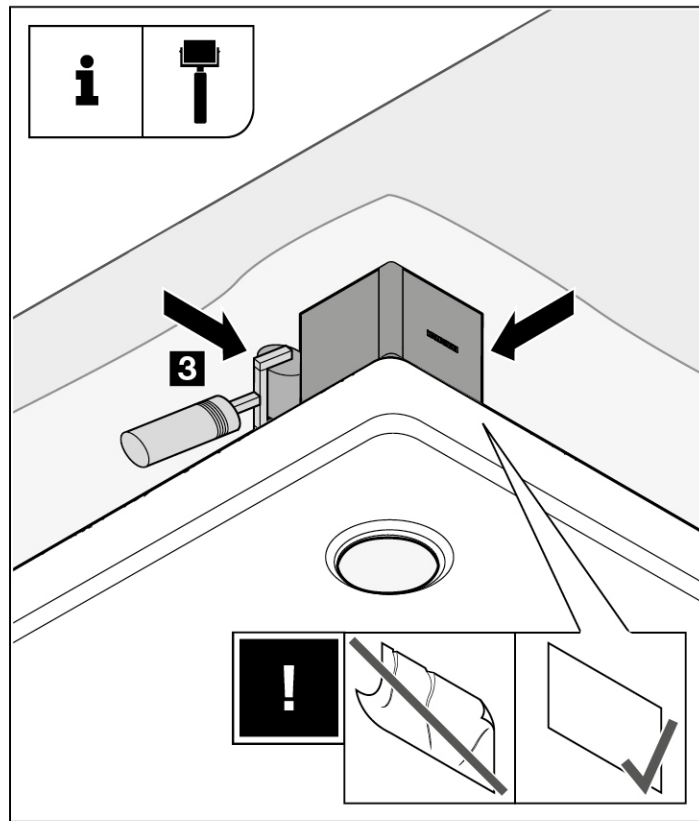
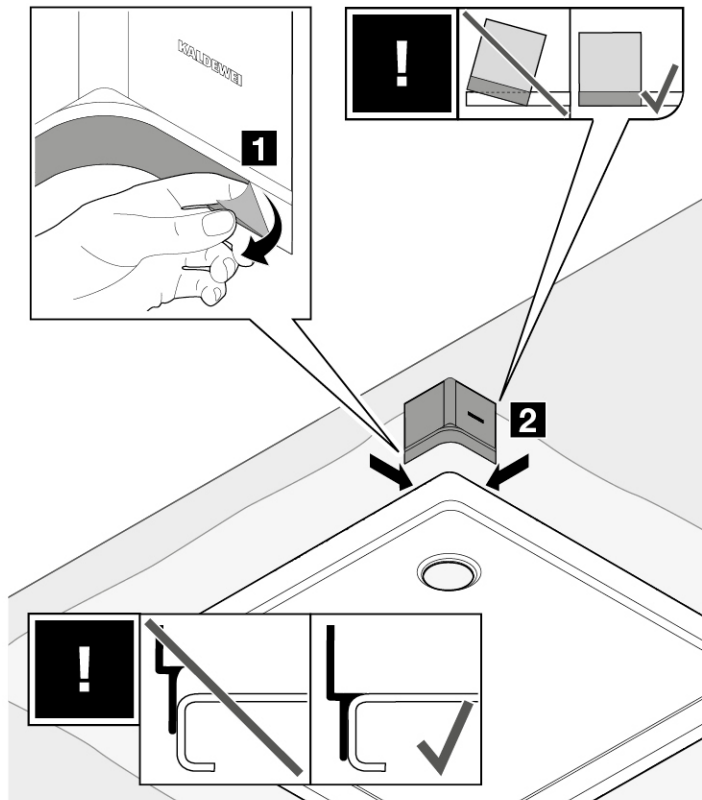

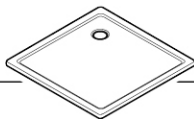
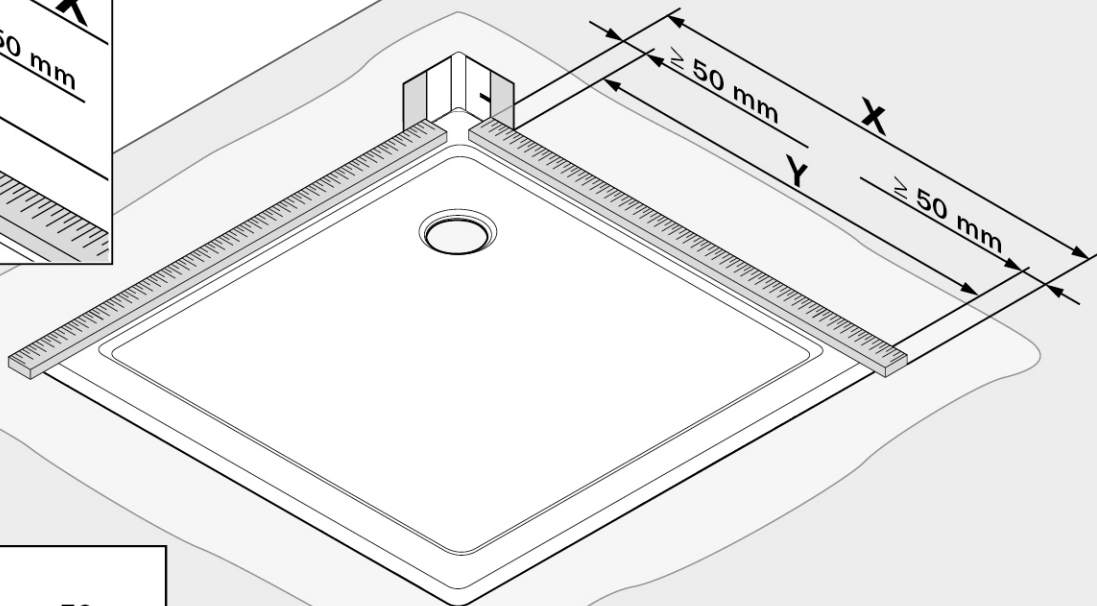
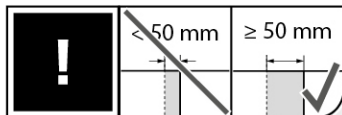
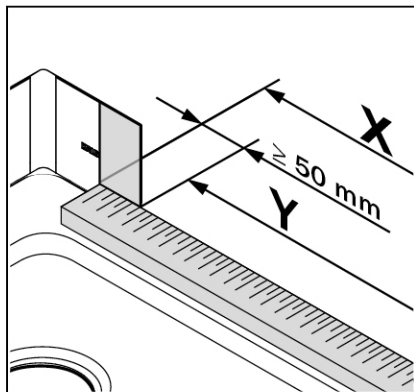
**A****6.****i** $X = Y + 50 \text{ mm} + 50 \text{ mm}$ 

Inch = mm x 0,0394



**A 7.**

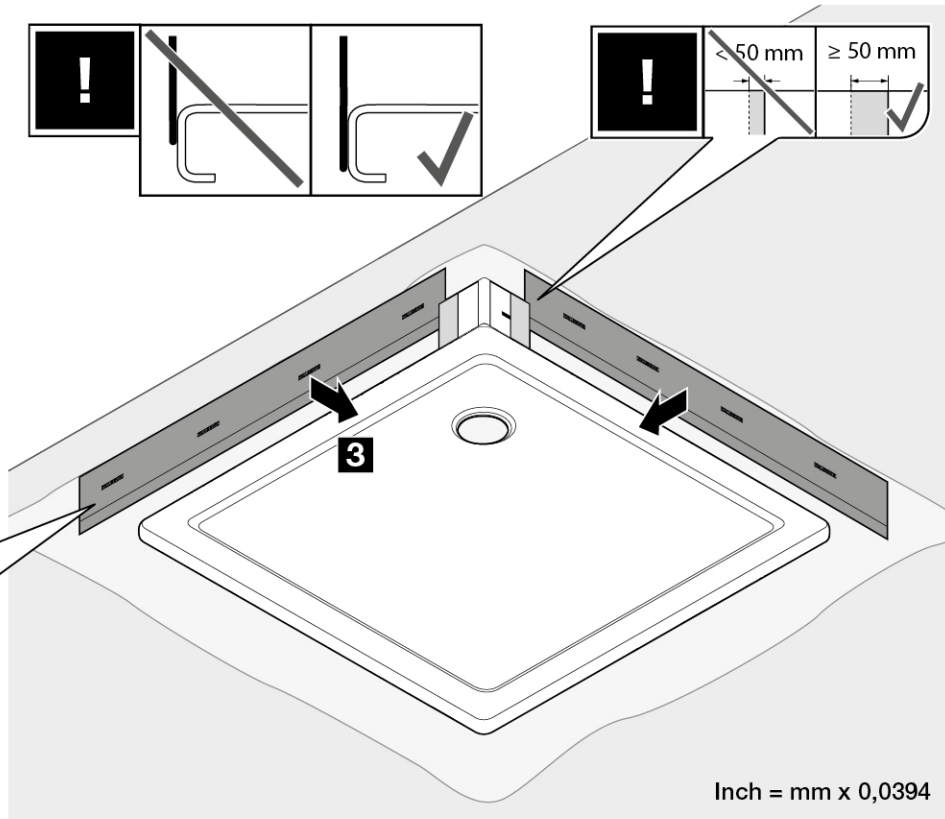
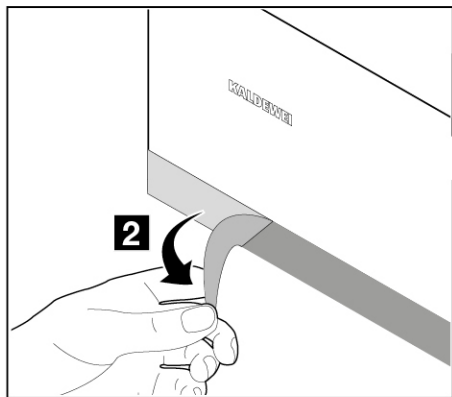
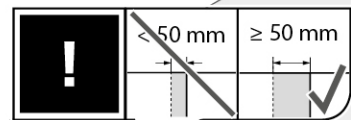
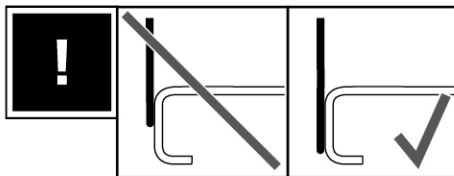
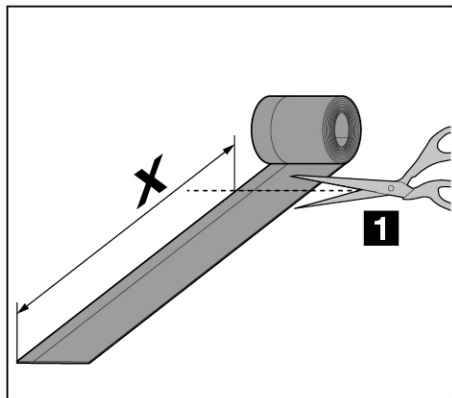

Inch = mm x 0,0394

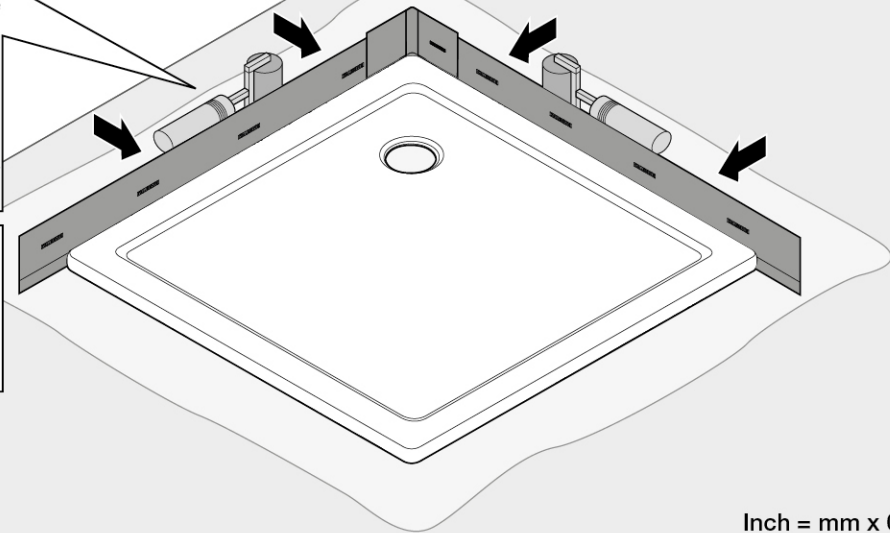
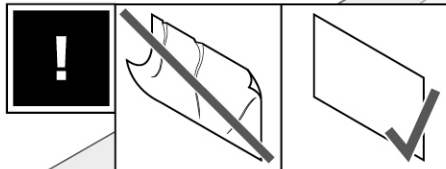
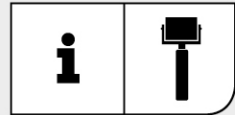
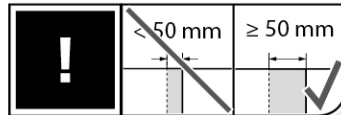
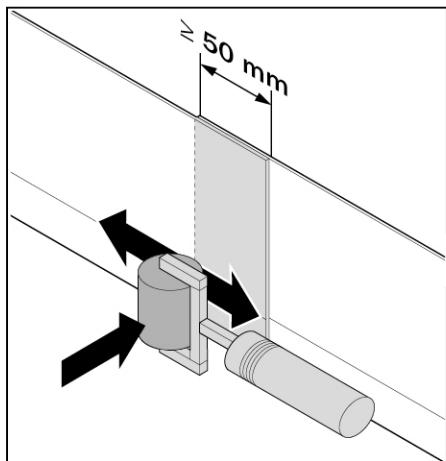

**A****8.**

Inch = mm x 0,0394

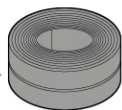

**A** **9.**

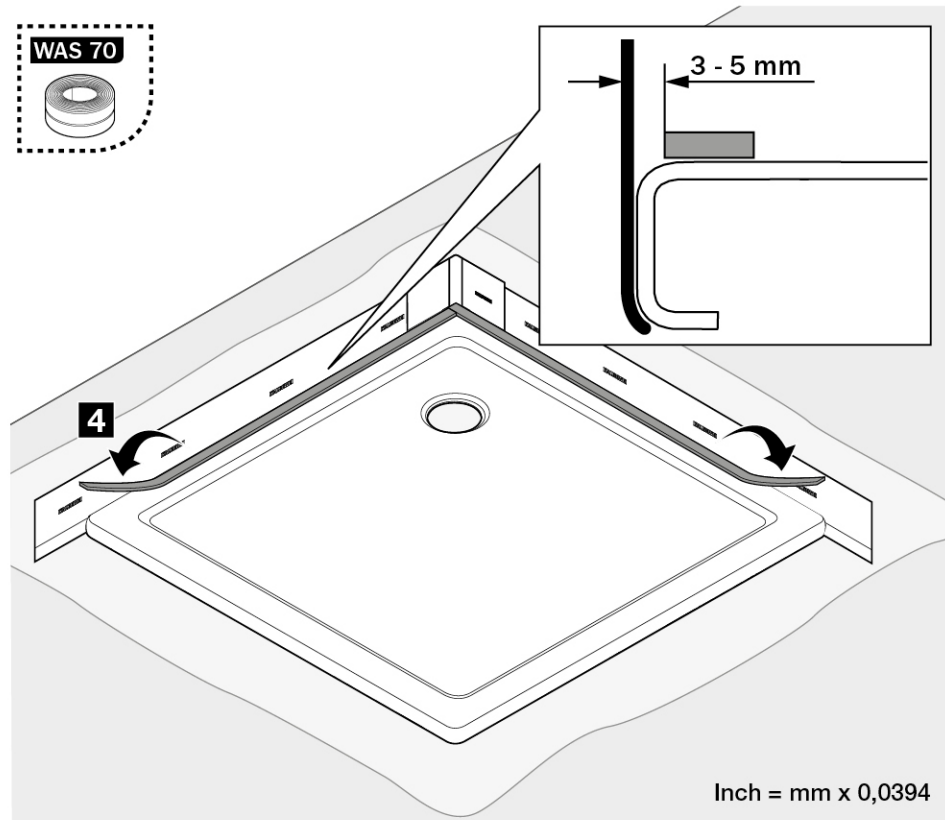
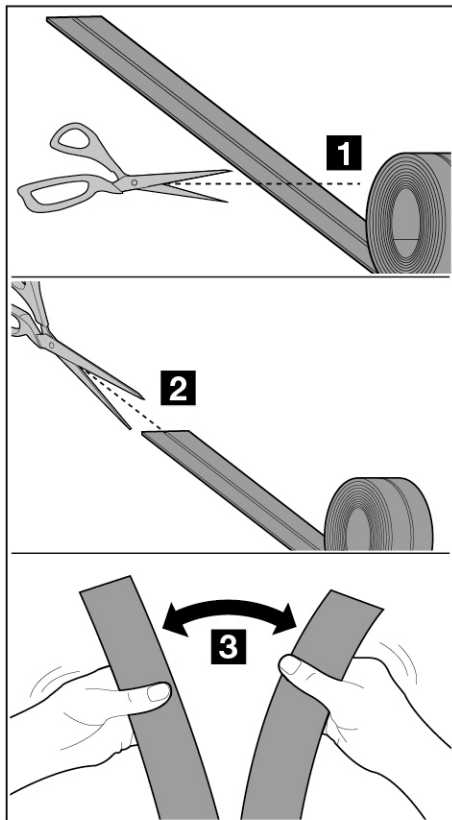

Inch = mm x 0,0394

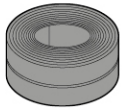

A 10.

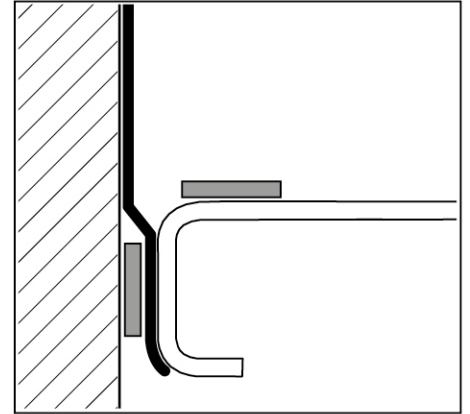
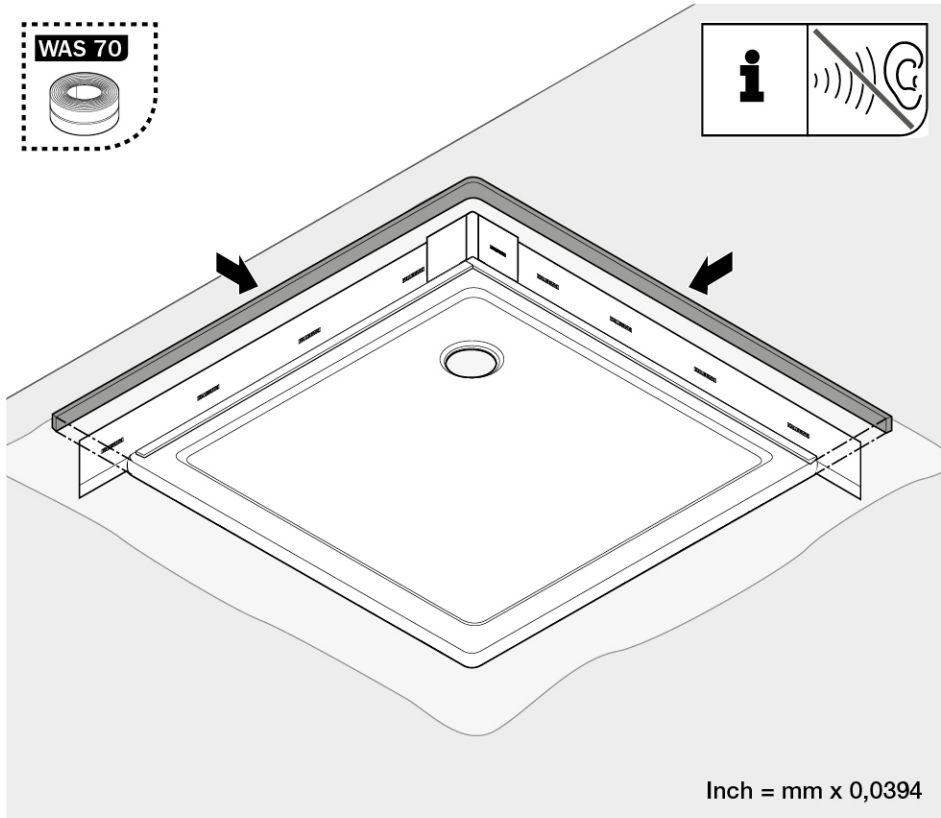
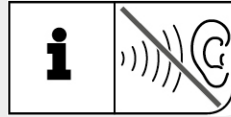

Inch = mm x 0,0394

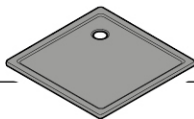

**A 11.**

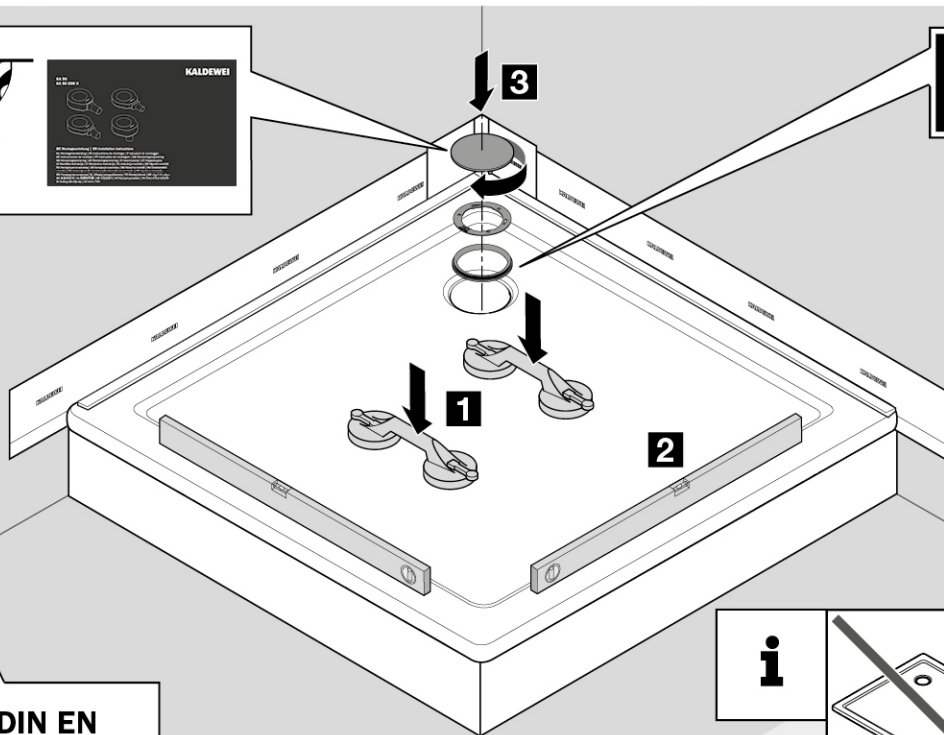
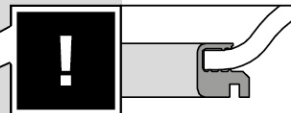
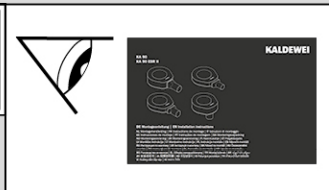

**DIN EN  
18 157**

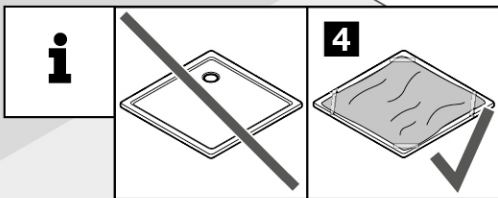

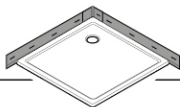
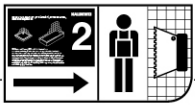

**A 12.**

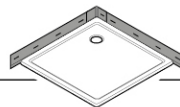
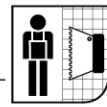

**A 13.**

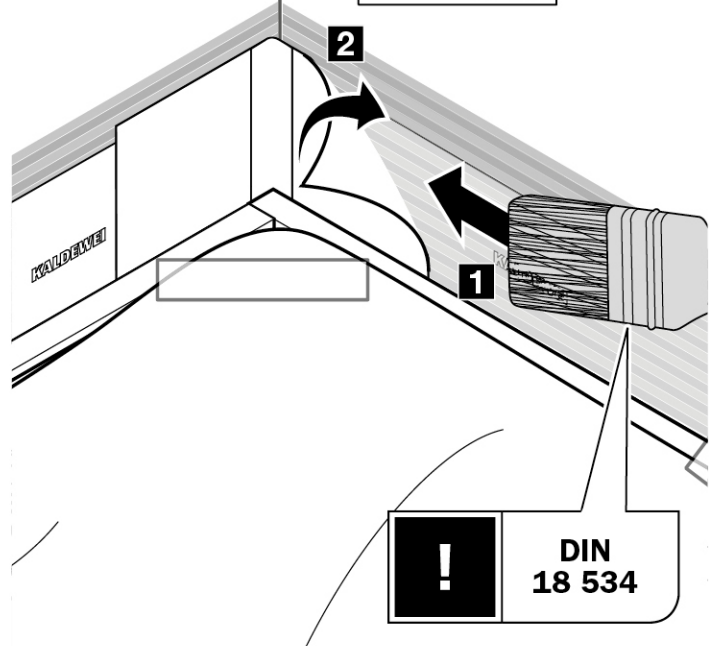
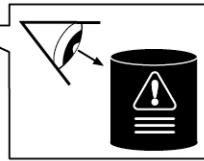
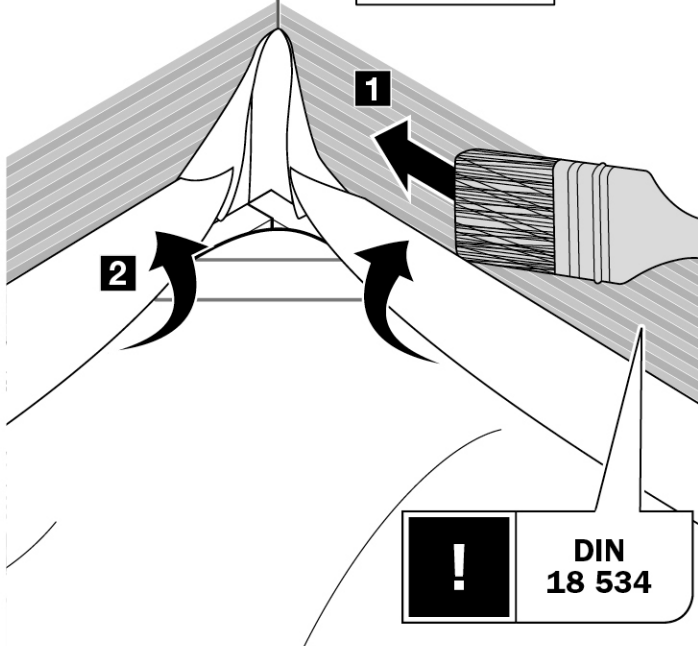
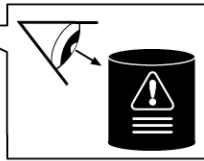

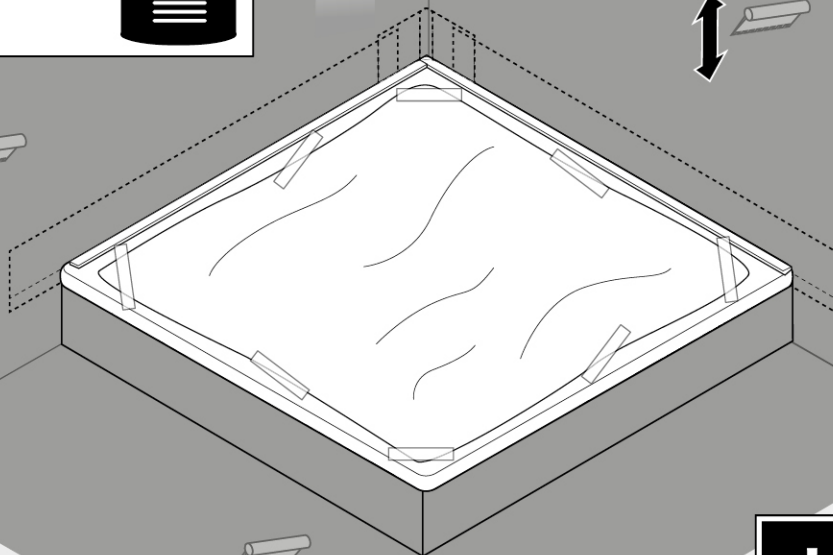
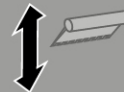
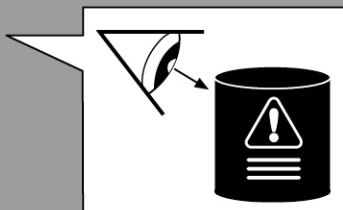
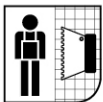

2



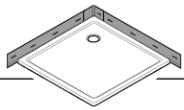

A 15.

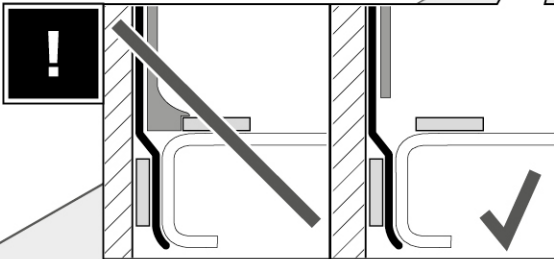
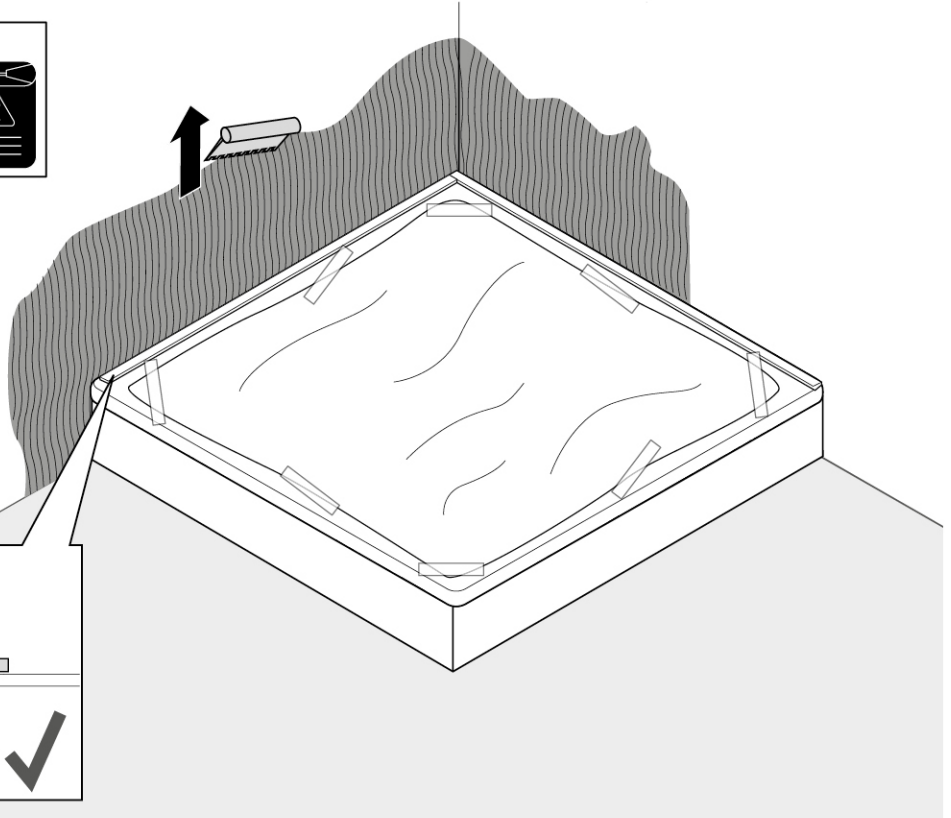
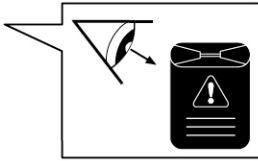
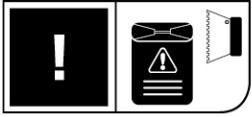

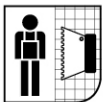

**A 16.**

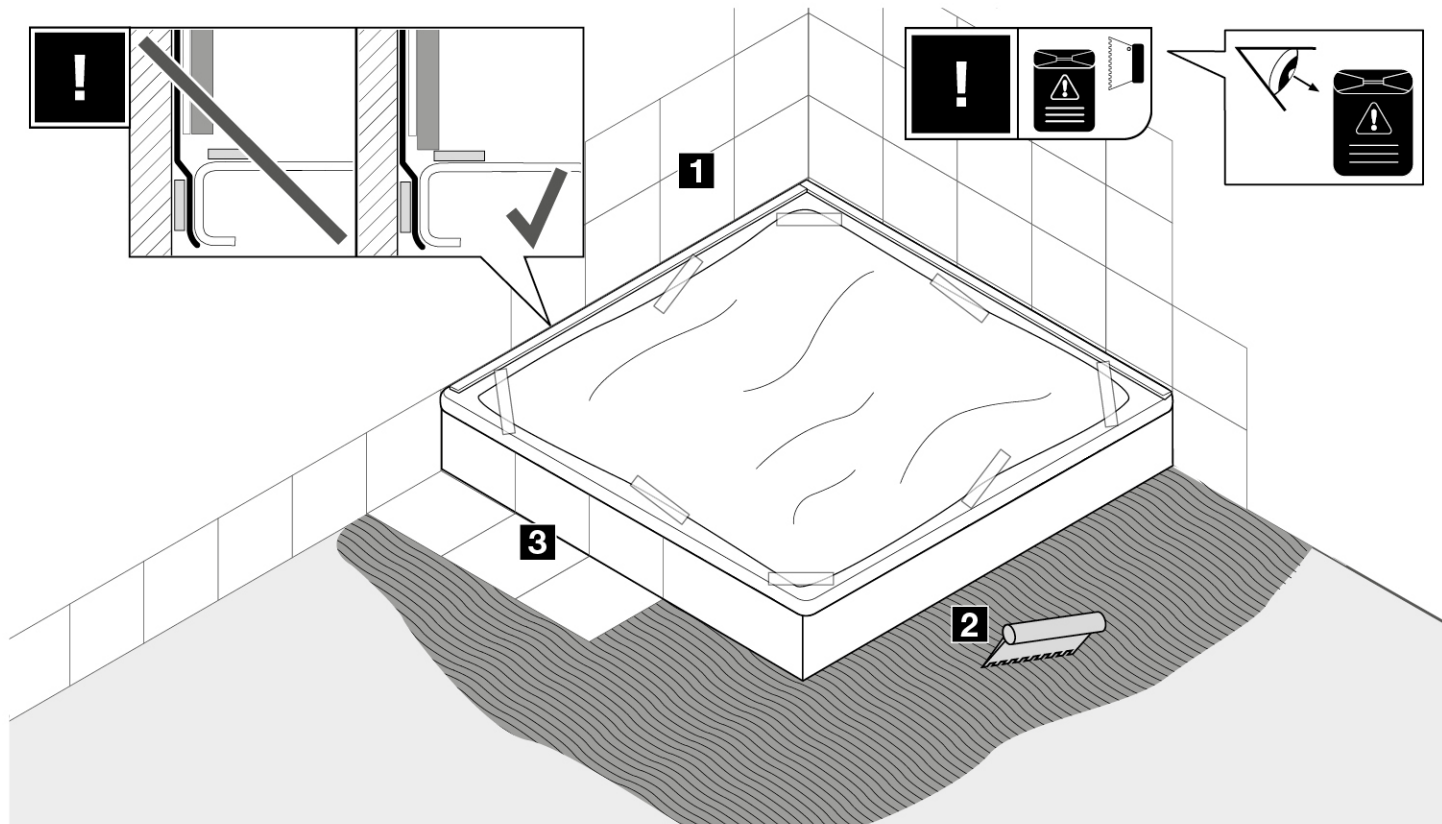



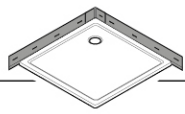

**A 17.**

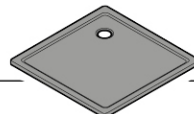

**A 18.**

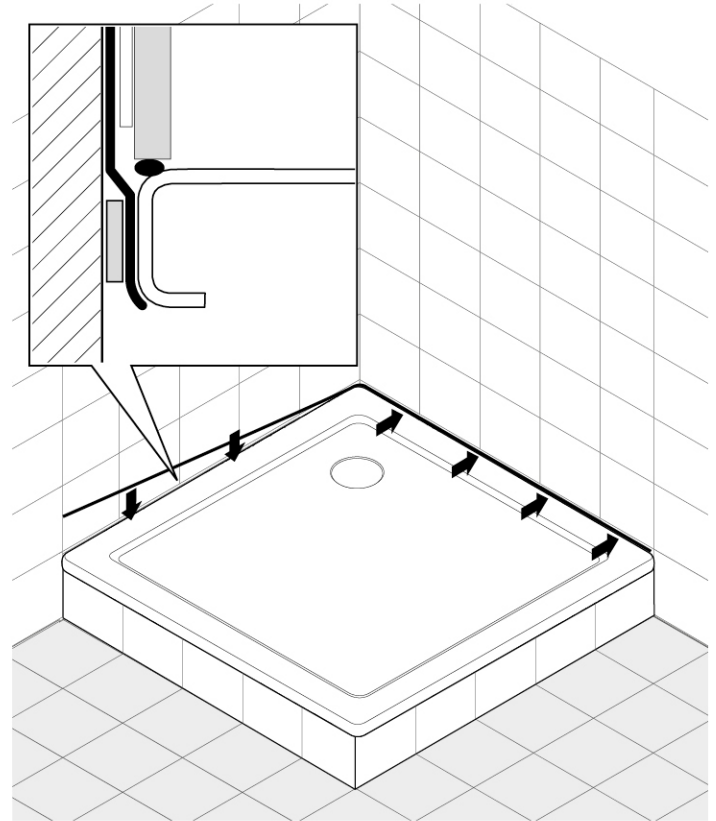
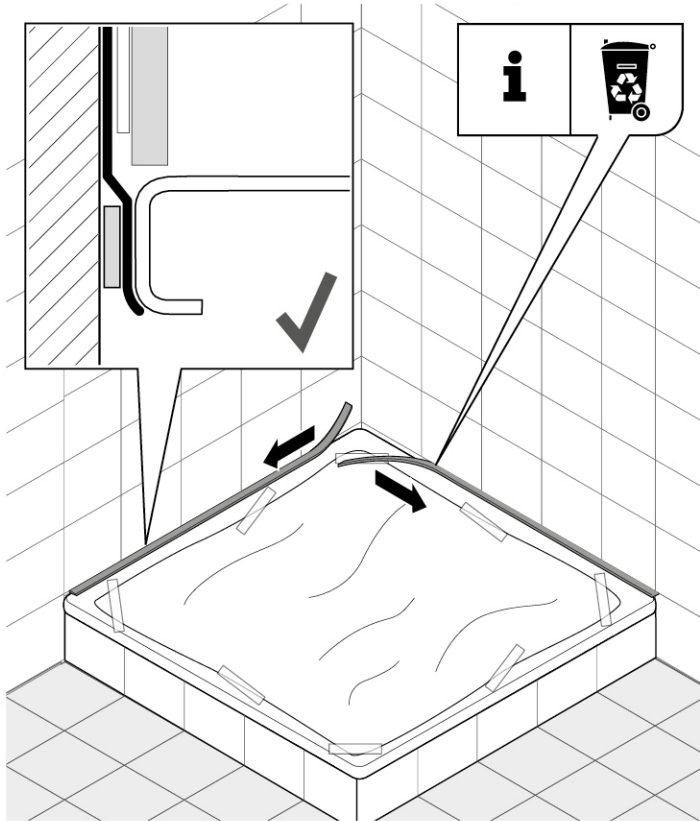

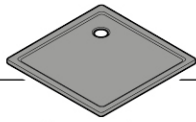
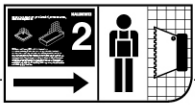

# A 19.



**DIN 52 460**

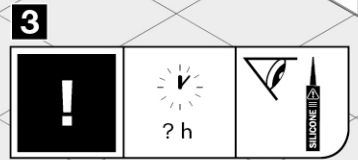
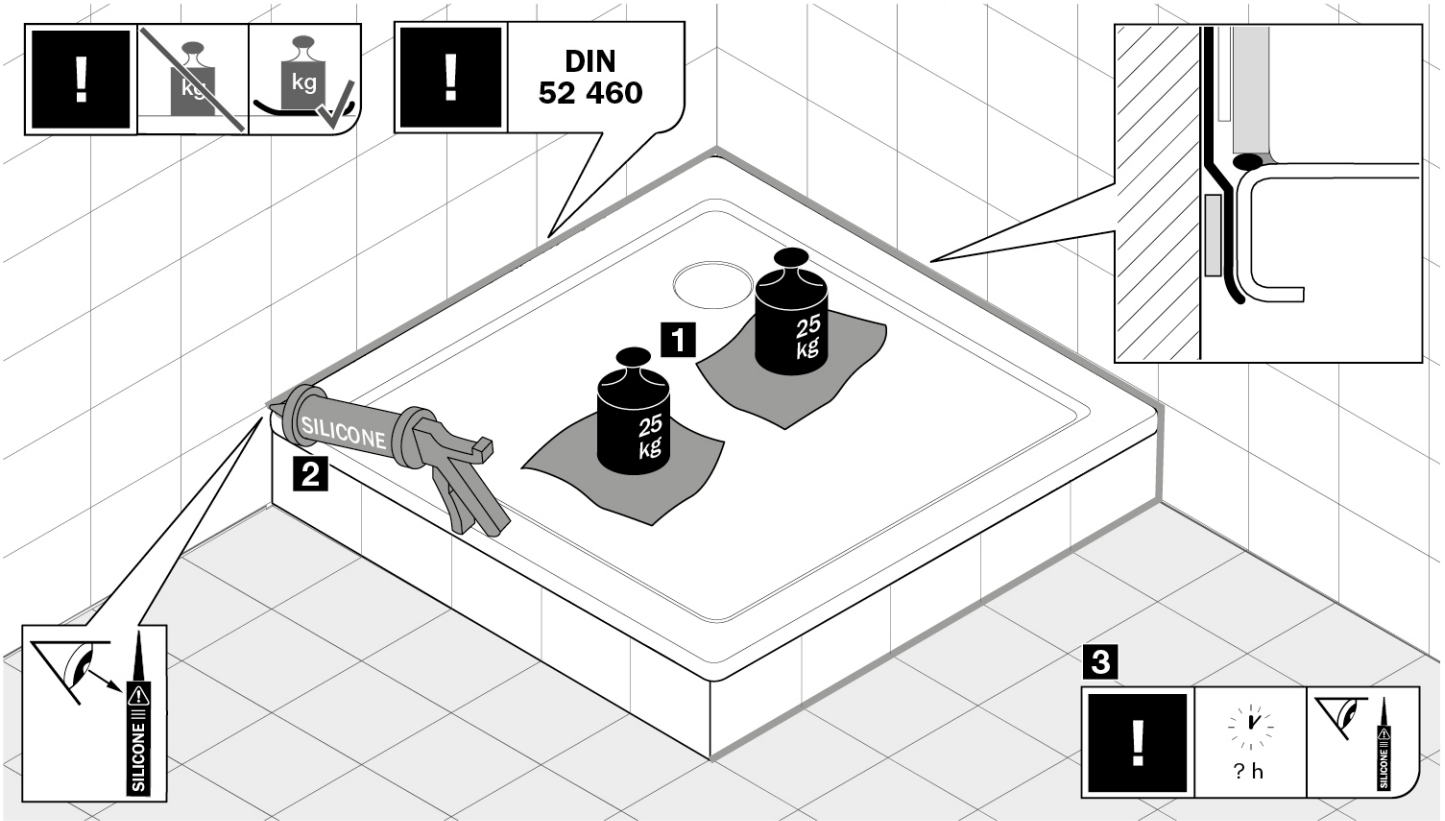
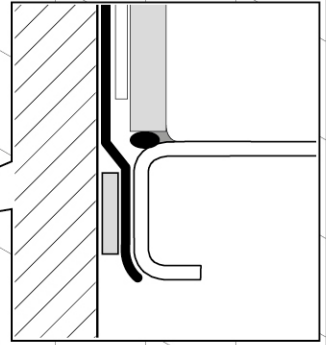

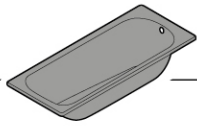
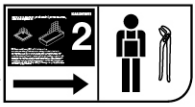

**B 4.**

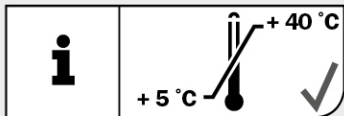
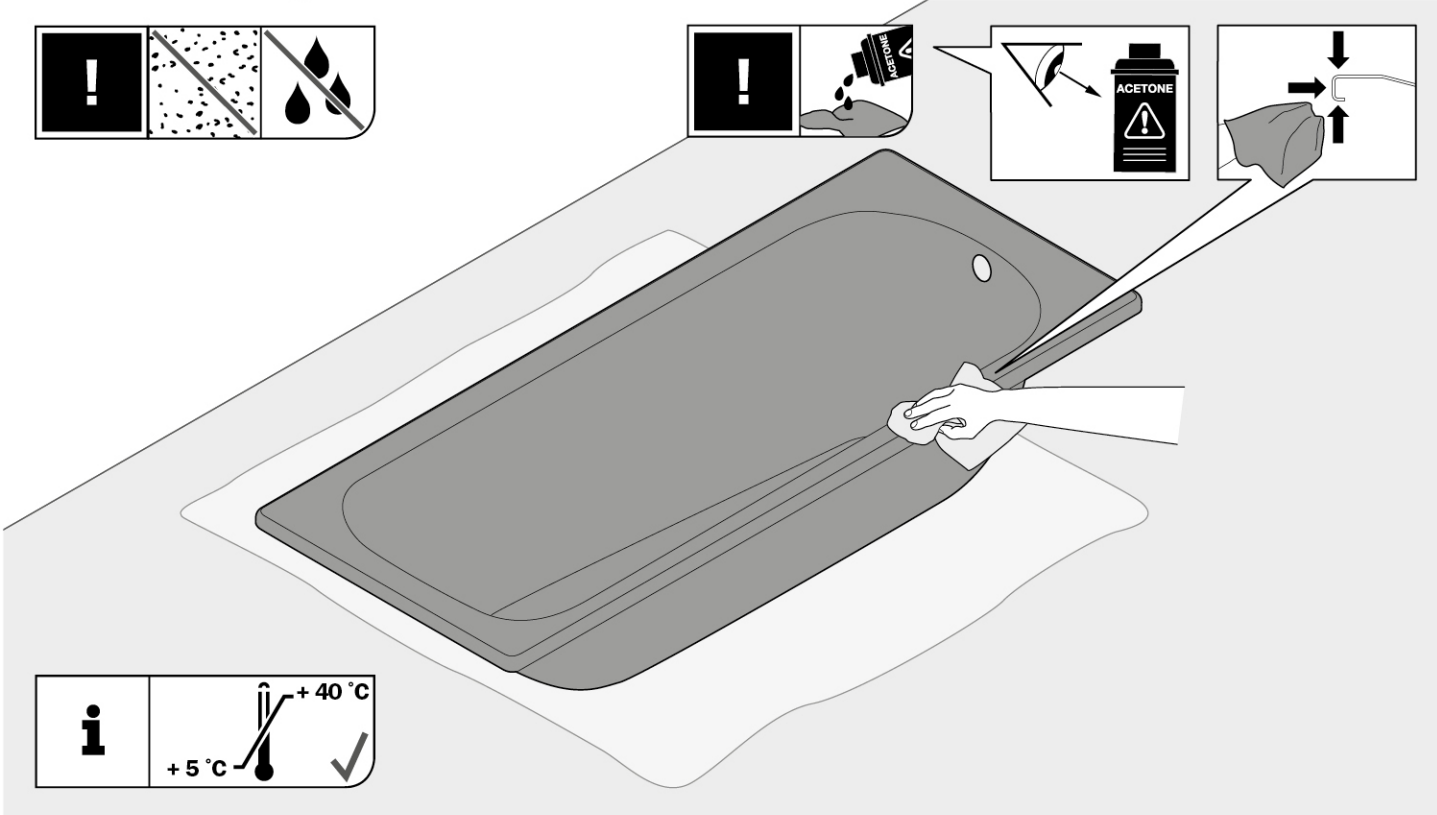
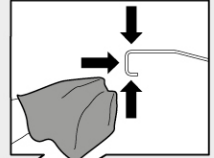
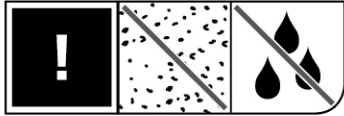

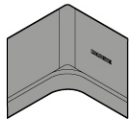

# B 5.

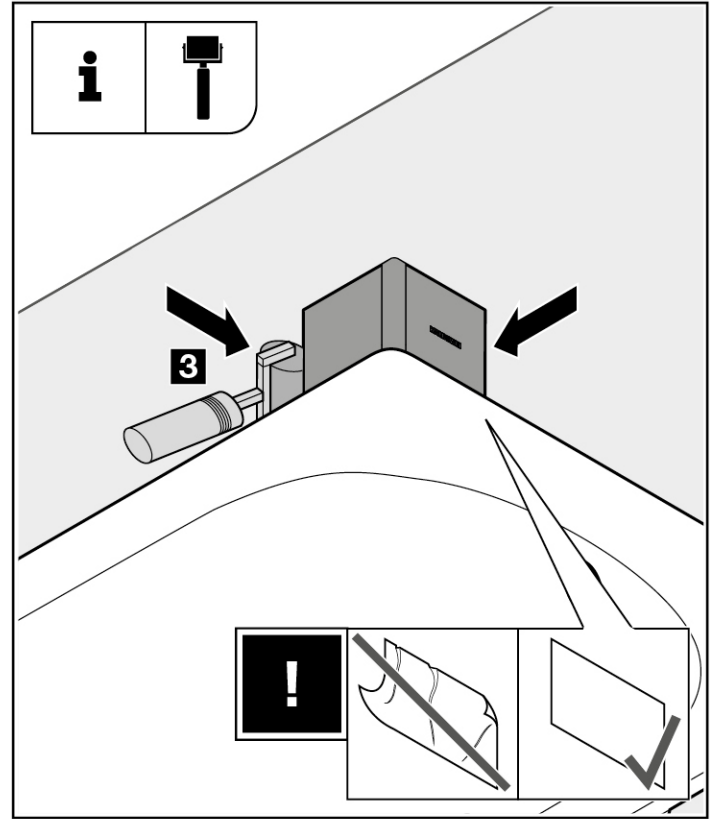
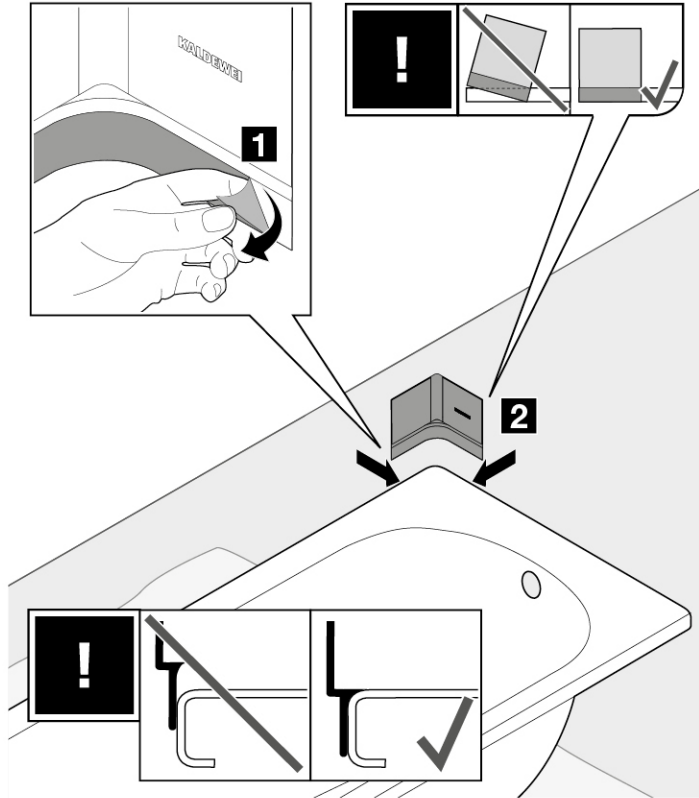

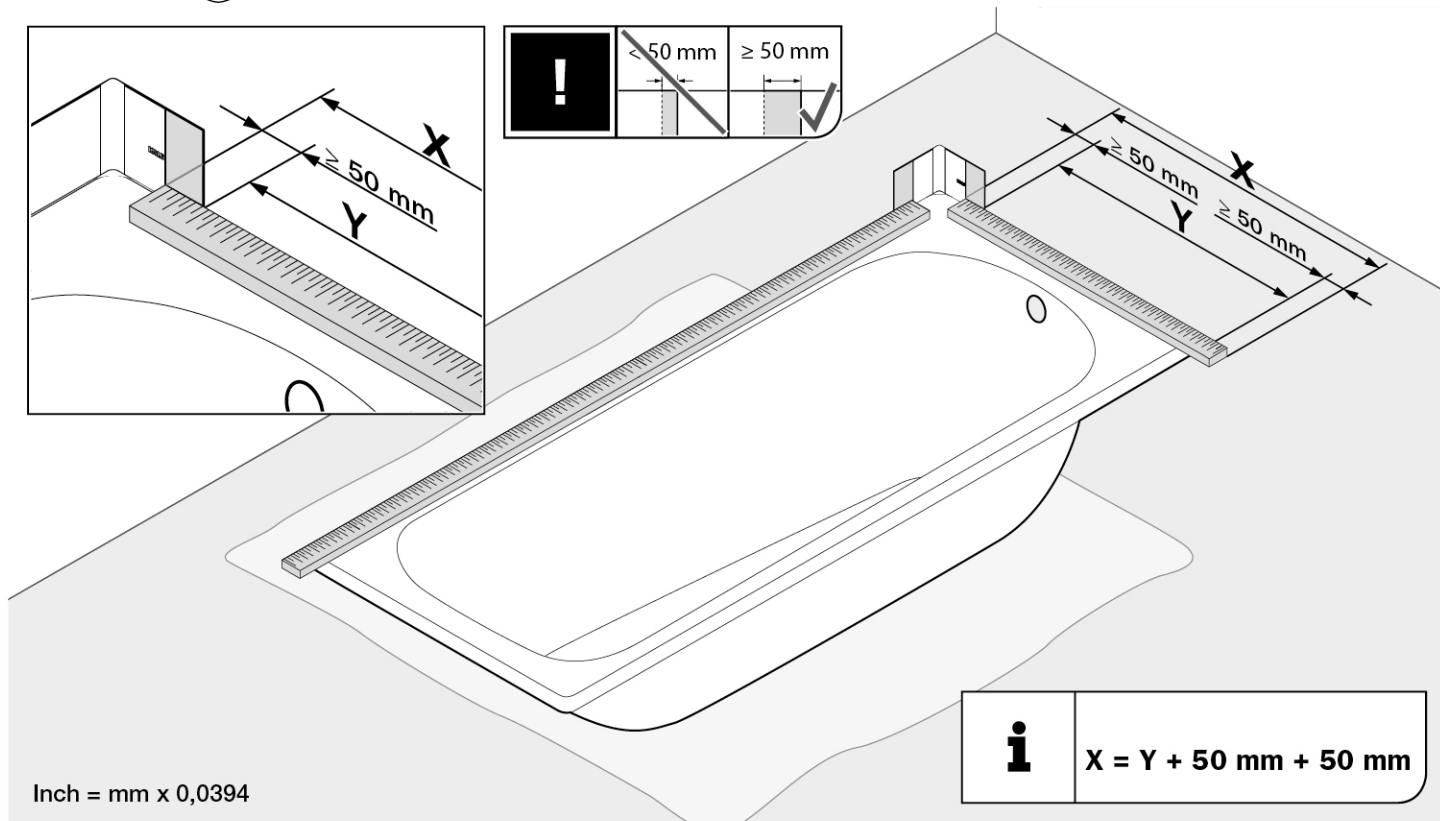
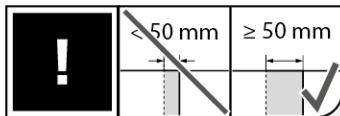
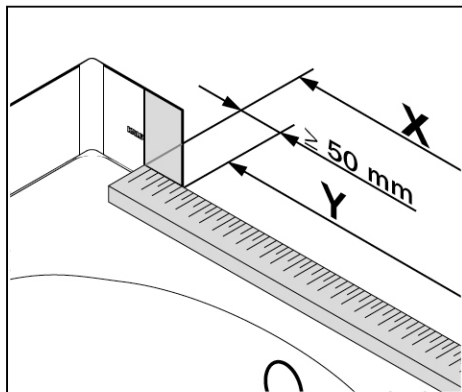
**B****6.**

$$X = Y + 50 \text{ mm} + 50 \text{ mm}$$

Inch = mm x 0,0394

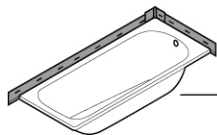

**B 7.**

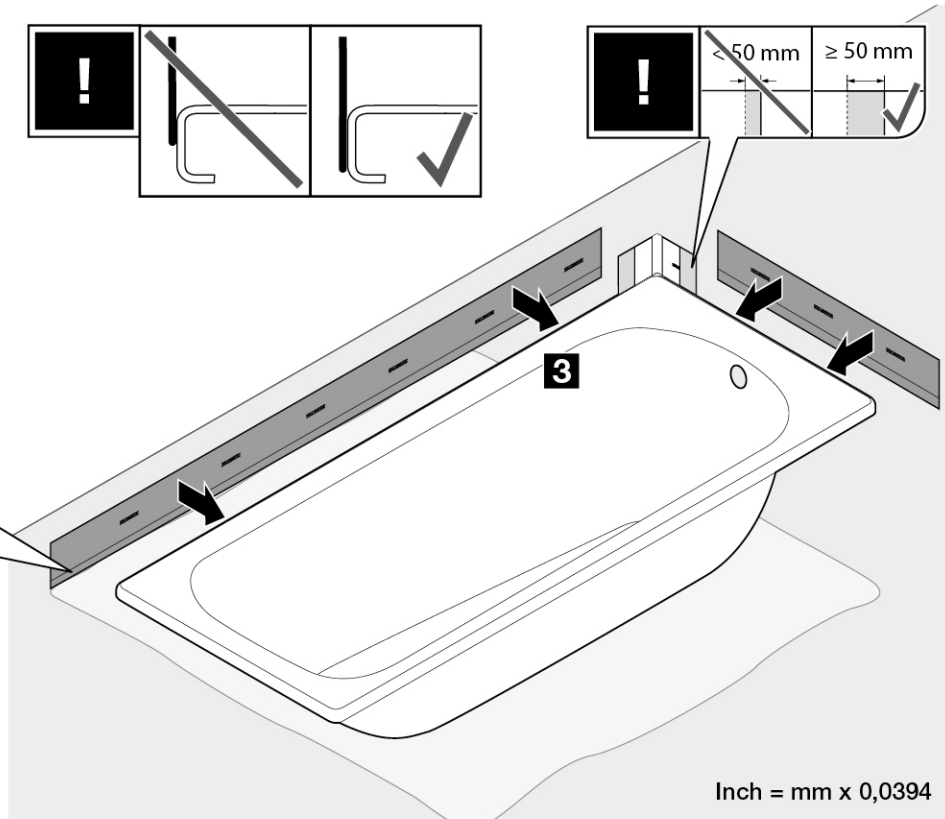
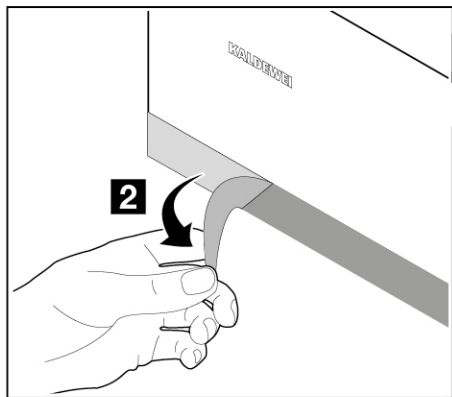
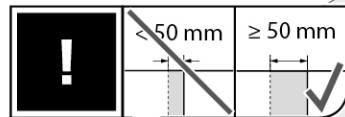
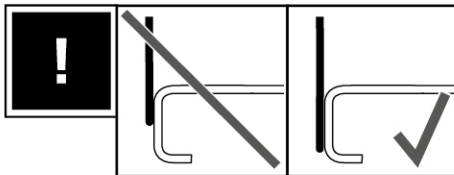
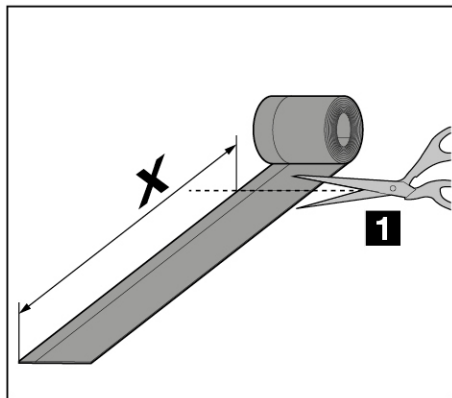

Inch = mm x 0,0394

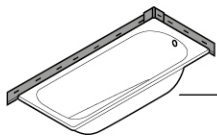
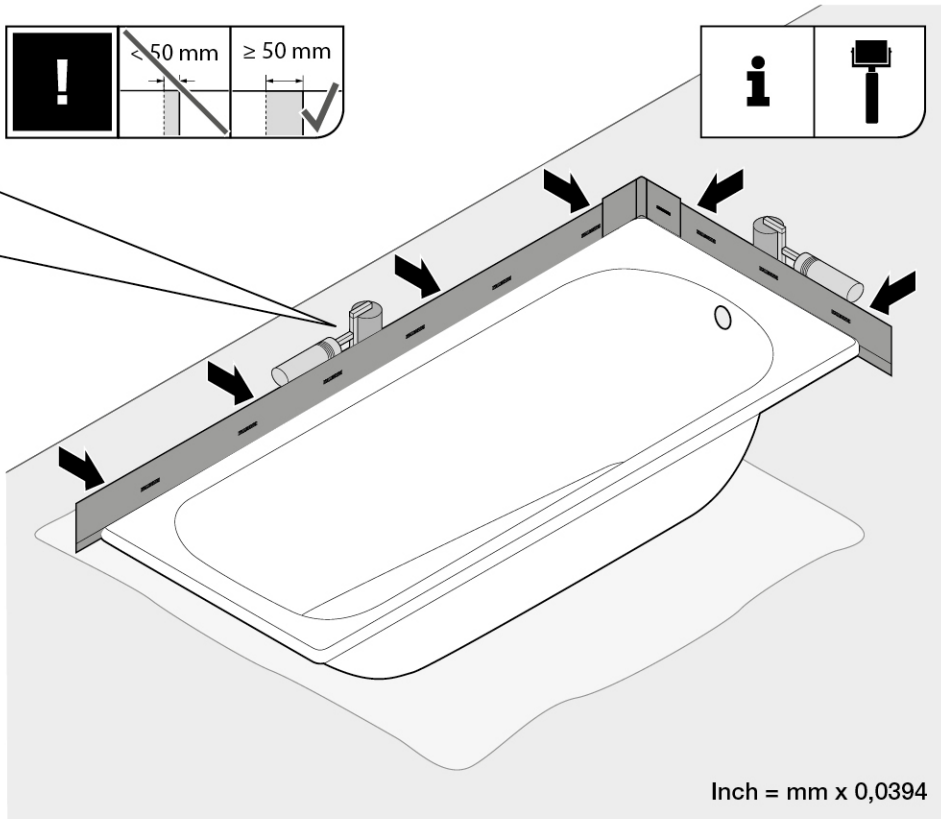
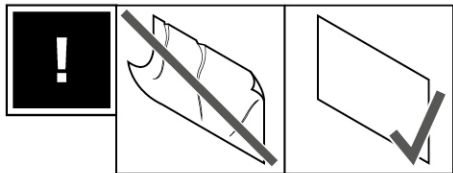
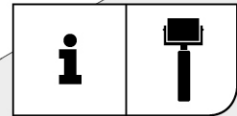
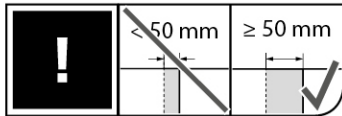
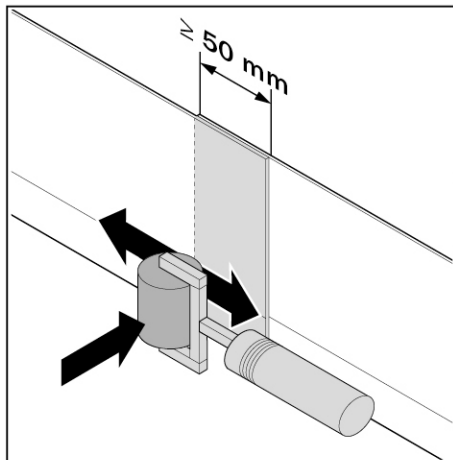
**B****8.**

Inch = mm x 0,0394

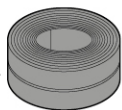

**B** **9.**

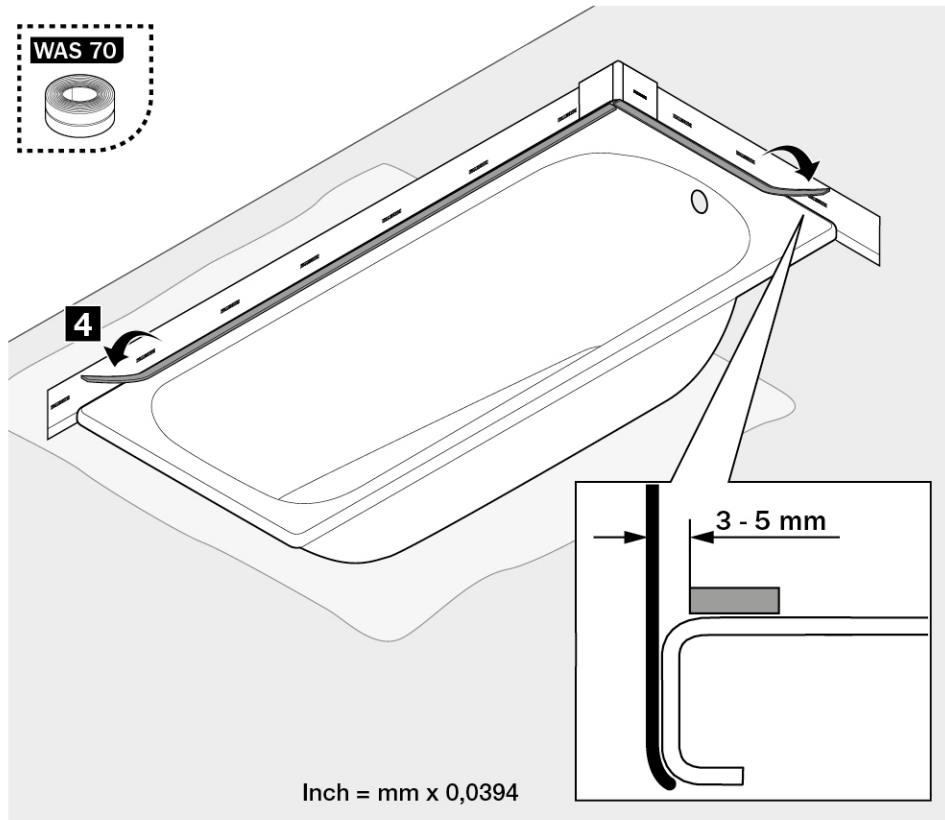
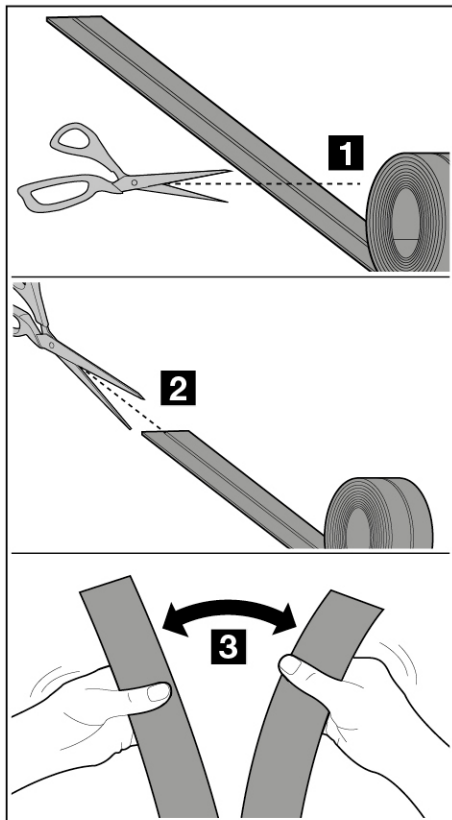



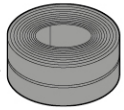

# B 10.

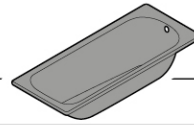

# B 11.

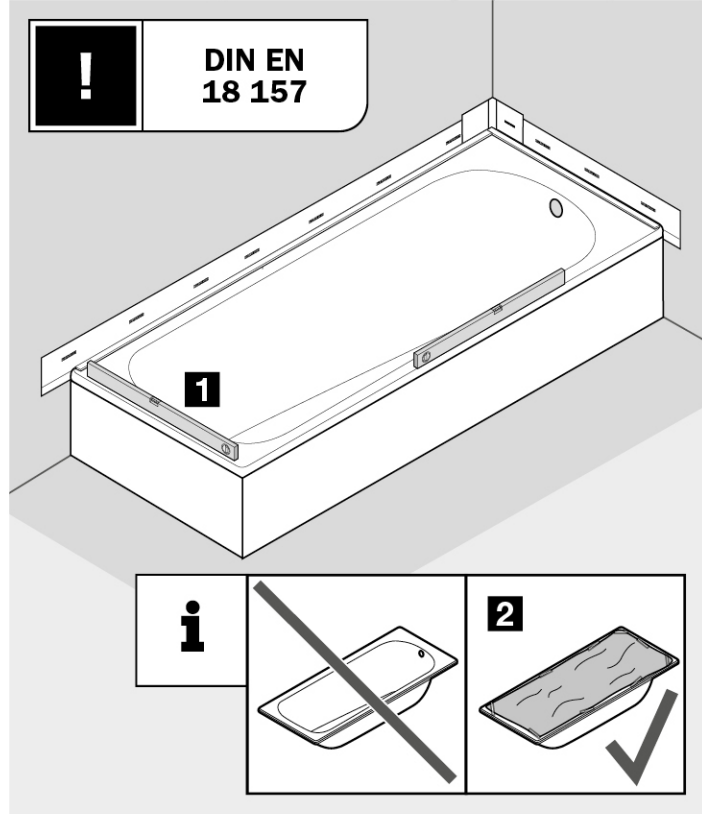
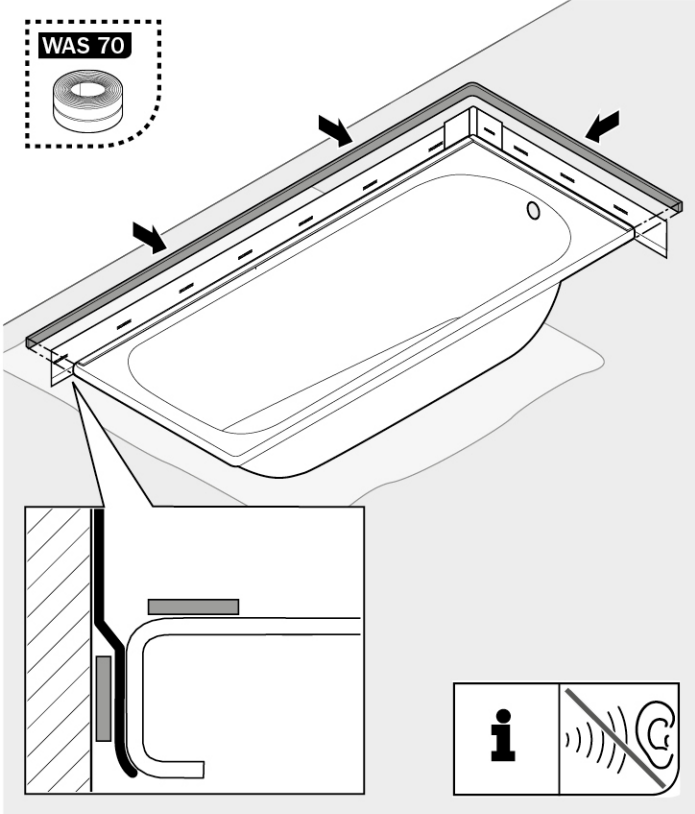

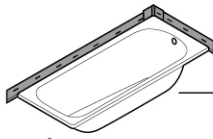
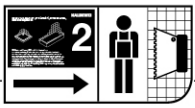

**B 12.**

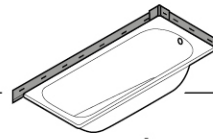
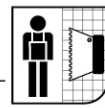

**B 13.**

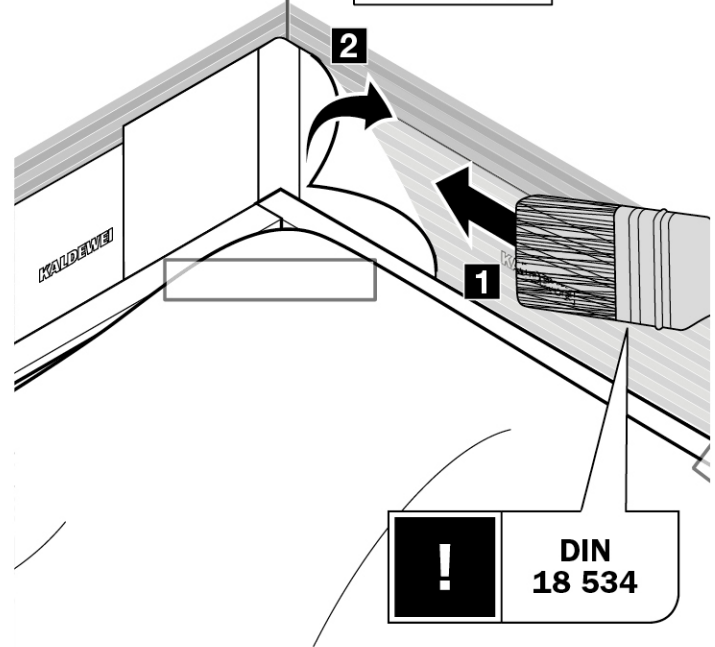
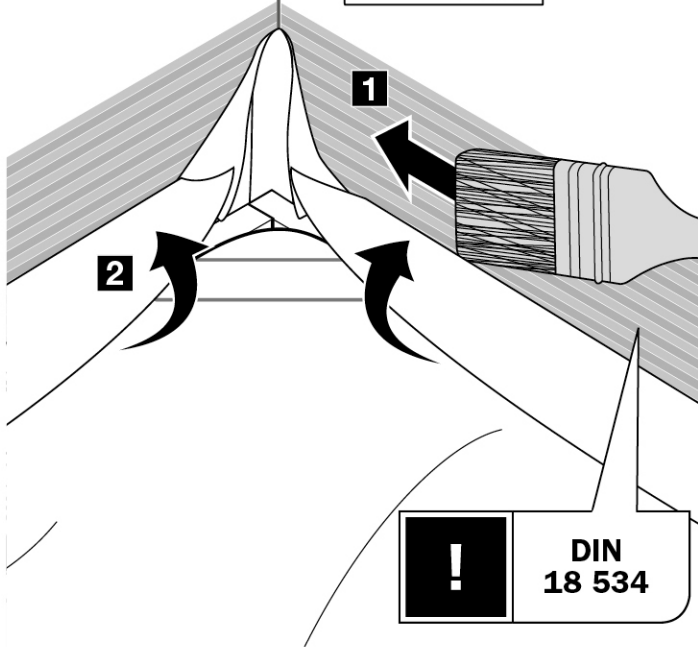
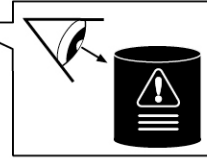
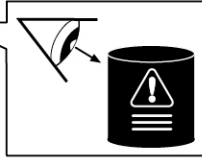
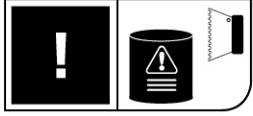

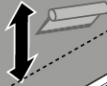
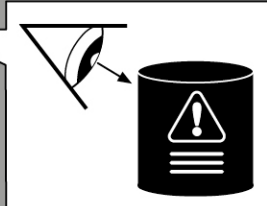
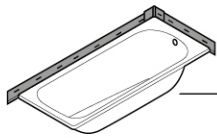
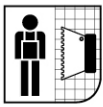

**2**

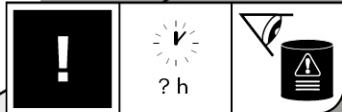

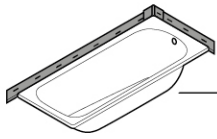

**B 15.**

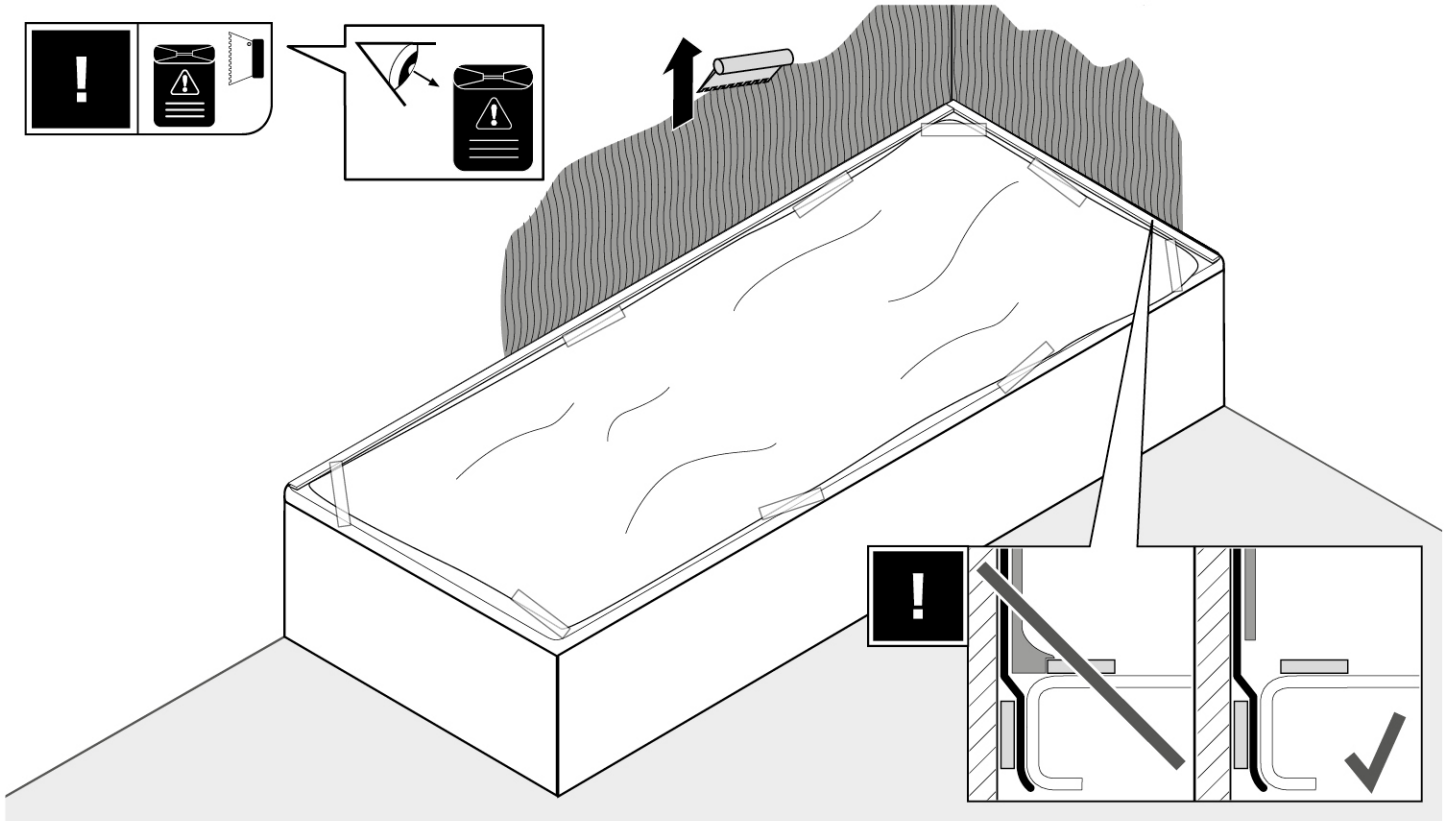
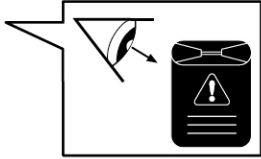
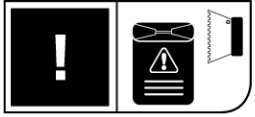

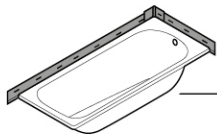
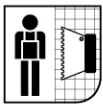

**B 16.**

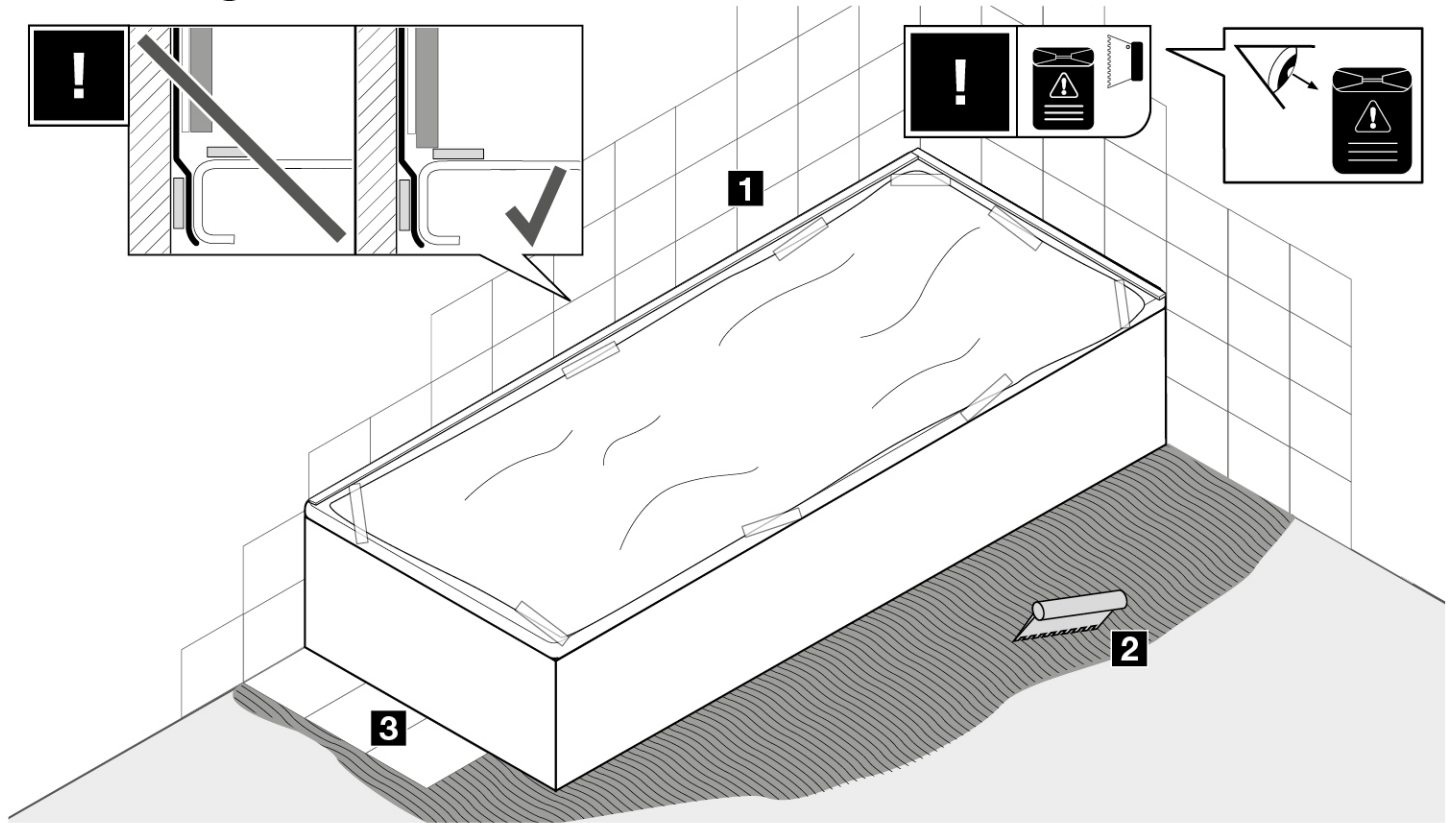
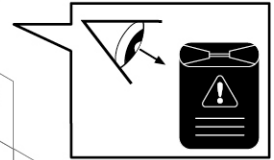
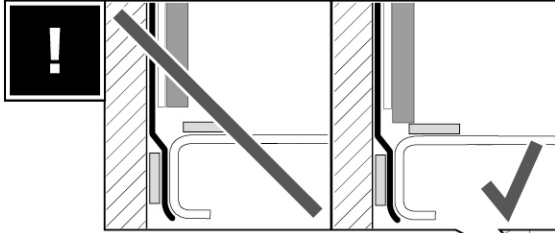

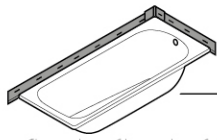
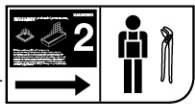

**B 17.**

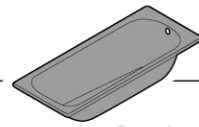

**B 18.**

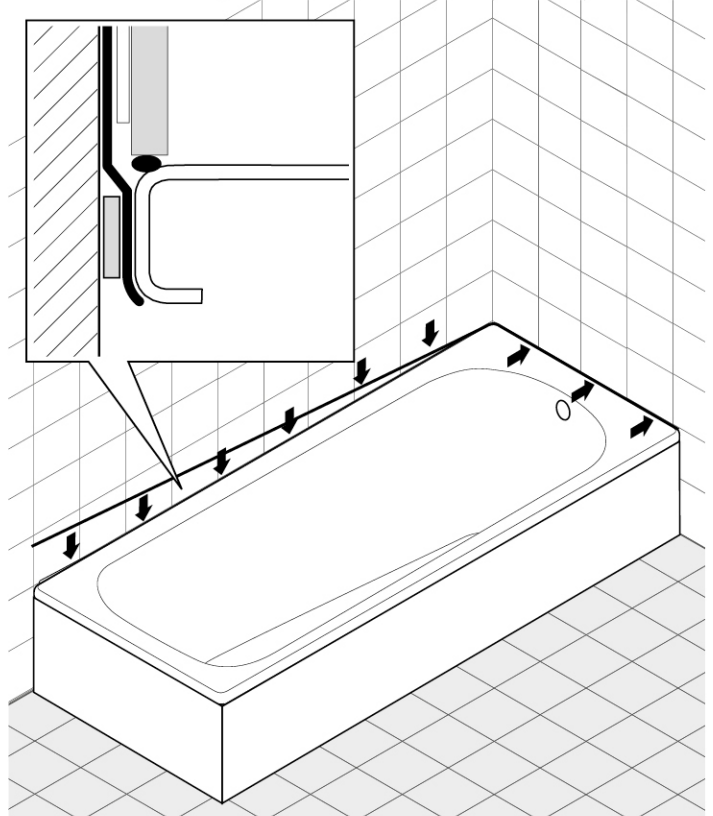
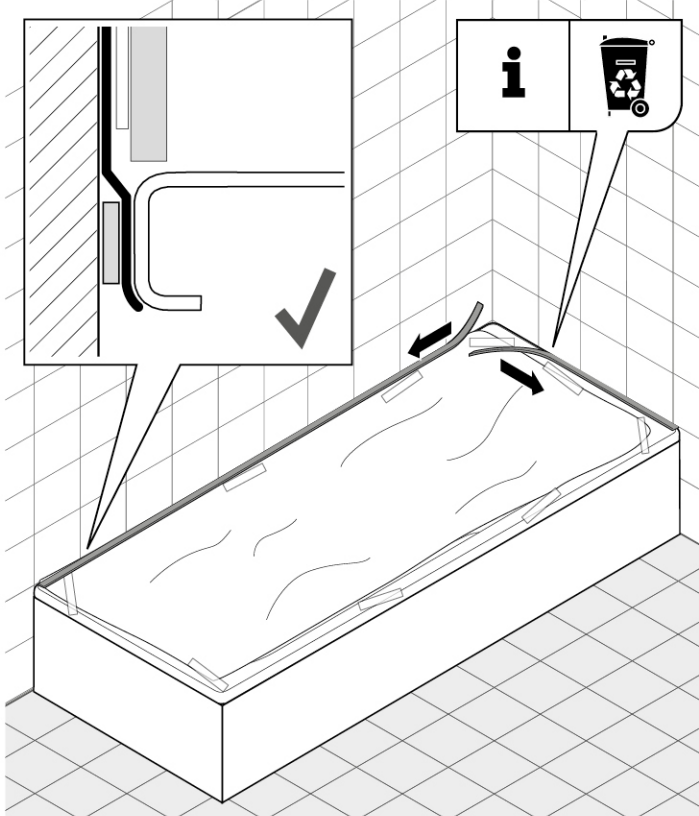

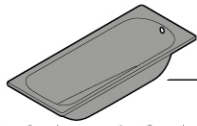
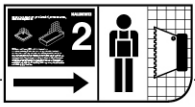

# B 19.

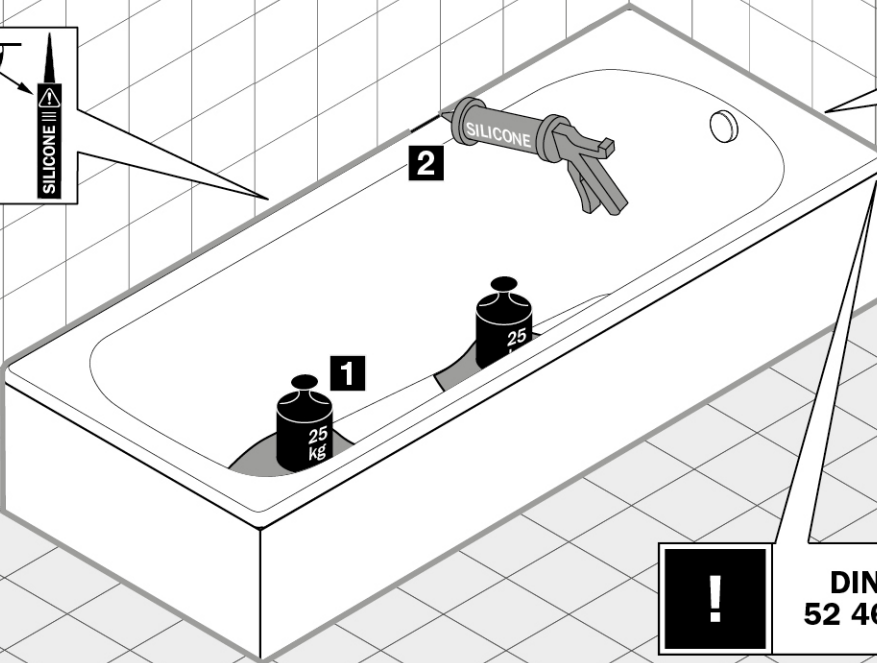
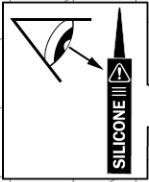

DIN  
52 460

3



# KALDEWEI



Franz Kaldewei GmbH & Co. KG  
Beckumer Str. 33-35  
D-59229 Ahlen

+49 2382 785 0

+49 2382 785 200

[www.kaldewei.com](http://www.kaldewei.com)

